



**Cortizo 4700
sliding doors
featuring**





Featuring the Multi-Award-Winning Korniche SpeedBead



It's our mission to achieve your vision

Korniche has a mission to bring inspirational products to light through innovative design and engineering. The Korniche Lantern was the first of its kind, a dedicated product designed from a clean sheet, using ground-breaking new technologies. The same methodology was applied to the equally innovative Korniche bi-folding door and again with the Korniche flat glass.

Since launch these multi-award winning products have been embraced by homeowners and builders alike, and our vision is to become the first brand you go to for smarter, better engineered and inspirational glazed products.

A Korniche product contains proprietary technologies which can be applied across multiple designs in our core product range. These unique Korniche Technologies are now being made available through some key product partnerships, offering a new slant on the application of our innovation. These collaborations with

other select glazing brands provide you with some distinctive advantages when bought from your favourite Korniche distributor.

Either an in house Korniche system, or a product featuring a Korniche technology, all our products are manufactured exclusively by us. This means you benefit from investment in the latest fabrication methods, a clear focus on engineering excellence and industry leading quality controls, Korniche products are consistently delivered to an extremely high standard.

Market leading slider with Korniche Technology

Where would BMW be without the M division? Mercedes without AMG?... Yes, the core products are proven market leaders and do exactly what you need them to, but those famous engineering partnerships just offer something a little better, more desirable. And that's exactly what a Korniche Technology partnership is all about.

Introducing the Cortizo 4700 In line sliding patio door with patented Korniche technology

Appealing specifically to the buyer looking to maximise views through their chosen door solution, The Cortizo 4700 sliding patio door is established in the UK as the go-to option. Affordable, reliable, with multiple configuration options and importantly easy to install. Its slim central interlock and sleek frame provides minimal sightlines with a clean modern aesthetic.

Korniche engineers have taken the standard form of the 4700 door and improved elements of the design with some key performance enhancements.

Korniche technologies speed up and simplify installation, provide slimmer sightlines with better vent integration, add a host of security features and some sleek new hardware options. All whilst still retaining the key features which make it a market leader.

We also add Korniche quality, after care, and gold plated 10 year end user warranty as standard.







PAS24-2022 SECURITY

Our doors come rigorously tested to keep your home fully protected. Certified to the advanced PAS24:2022 standard, their strong, durable aluminium frames come with enhanced security, from our high strength shoot-bolts.

The lockable shootbolt handles have an innovative anti-back drive feature engineered into it. Even unlocked, a forced entry attempt can't rotate the handle to open the door.

SPEEDBEAD

The unique patented SpeedBead, a secret ingredient allowing our sliding patio doors to be glazed in seconds, along with a neat groove design allowing the seals to be hidden within the frame.



Simply better together

Expertly engineered, the proven Cortizo 4700 sliding doors are the market leader for good reason. Exuding the same quality in function as they do in design, they are an even better proposition when packed with Korniche Technologies that enhance security, aesthetics and ease of installation.

Cortizo Core

Clean modern lines are provided in premium quality thermally broken aluminium. A slim 47mm interlock provides a strong central closure with no requirement for complicated bonded glazing. High precision running gear provides effortless movement for many years all wrapped up in a installation friendly package.

Keeping control of the temperature in your home is vital, especially during the winter. Our aluminium frame parts have deep polyamide thermal breaks which keep outer and inner parts thermally isolated from each other minimising heat transfer. Bespoke designed seals complete the picture protecting the system against air and water ingress. Our sliding doors are designed to keep heat in and weather out.

Enhanced with Korniche Innovations

Our in-house locking shoot-bolt handles perfectly compliment the slider and are paired with all new pull handles. PAS 24 is now standard issue thanks to the fully lockable shoot-bolt gearbox, preventing operation from the outside even when unlocked thanks to anti-backdrive technology. Document Q compliance is achieved when specified with laminated glass.

A signature feature of Korniche, trickle vents are fitted through the top of the door frame meaning a super slim extension piece is all that's required for the plaster line. This design is a more cost effective and aesthetically pleasing solution for your home.

Our unique patented SpeedBead allows the doors to be glazed in seconds, saving time and complexity during installation. Slimline pre-fitted seals almost hidden within the frame mean slimmer sight-lines between glass units, maximising light and views. Another SpeedBead advantage is the ability to remove and replace fitted bead assemblies without risk of damage to any critical components.

bespoke options come as standard

Award-winning manufacturing tailored for you

Creating stunning open views for your home, our slimline sliding doors have been engineered with versatility in mind. Sliding doors can be fabricated in a number of configurations on double or triple tracks to cater for openings of any size.

Once you've chosen a configuration, choose from our range of standard or bespoke coloured aluminium profiles. Whichever you do choose, the profiles will be professionally powder coated at point of manufacture meaning the very high quality is always the same. All of our thermally broken parts have their central polyamide sections installed after each half has been coated. This is to ensure stark black lines create a smart contrast between the two elements with no over spray.

Powder coated finishes don't just offer a wide range of colours, the tough, durable, polymer is highly resistant to discolouration along with wear and tear, ensuring easy maintenance over the long life of the product.

Glazing is available with toughened (as standard) or laminated options. Integrated blinds are available for

most glass configurations and are detailed in the next section.

A range of hardware options complete the look of your product before you, or your chosen installer, moves into the more technical selections where Korniche still offers market leading choice.

Frame options are available to allow Internal floors to be level and the installation position adjusted to reduce step-over to a minimum.

Finally, choose whether or not the door requires slimline trickle ventilation.

10 Year Manufacturers Warranty

Engineered in the UK to ensure the highest level of quality, endurance and reliability, all Korniche products come with a 10 year warranty against all parts and manufacturing.

Quality Assured

We manufacture our products to exacting tolerances, with intensive quality check and tests.



Colours

Profile is available in standard stock or bespoke colours

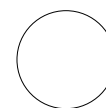

RAL 9910
Gloss White

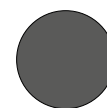

RAL 7016
Matt Anthracite
Grey



RAL 9005
Matt Black

We offer more than 150 colours in matt, satin or gloss, including the option to have different colours on the inside and outside of the frames. This gives you total freedom to match both the interior and exterior style of your property. Bespoke colours add approx. 5 weeks to lead time.





Options

- Traffic pull door and shootbolt handles are available in finishes of black, white, grey, polished chrome or brushed stainless steel.
- 180mm double track and 250mm triple track cill options
- Trickle vents are fitted through the head of the door providing a more aesthetically pleasing and cost-effective solution. A 16mm frame extender provides space for plaster board.
- Available in black, anthracite grey, or white and delivering 3333mm² of airflow per vent
- 16mm or 38mm frame extender profiles if required

Traffic handles



GREY



BLACK

BRUSHED
STAINLESS STEEL

CHROME



WHITE



SHOOTBOLT & KEY

a splash of colour

with Uni-Blinds® sliding venetian integral blinds

Venetian Uni-Blinds are designed to match any home. With a range of colours to choose from we're certain there is one perfect for you. In addition, anthracite grey and black is exclusive to Uni-Blinds and compliments perfectly the anthracite grey and black powder coated frames.

Cordless Control

Based on the technically proficient Screenline integral blind system from globally renowned manufacturer Pellini, the SL20SV provides a slick visual result with no cords on the face of the glass. Like all Screenline blinds, the SL20SV sliding system represents **the highest quality and operational reliability of any integral blinds.**

The blind is encapsulated within the two glass panes of a double glazed unit, **the thermal efficiency is optimised thanks to a warm edge spacer bar as standard.**

SV System Benefits

Closed-loop belt transmission system allows smooth and long-lasting function of the blind.

External magnetic slider is treated with a patented antibacterial finish, providing a long-lasting protective function against viruses.

Fully compliant with child safety standards.

Requires only one device to raise and tilt the slats.

PLEASE NOTE:-

Suitable for double-glazed units only, with 16mm or 20mm spacer bar

SIZE RESTRICTIONS APPLY:-

Toughened Glass: Max area 2m² / Max width 1.5m

Laminated Glass: Max area 1.6m² / Max width 1.2m

slat colour

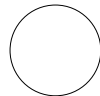

S102 WHITE*
Solar reflection 70%
Light reflection 78%
Solar absorption 30%
Standard colour



S149 CREAM*
Solar reflection 68%
Light reflection 75%
Solar absorption 32%
Standard colour



S157 SILVER*
Solar reflection 43%
Light reflection 44%
Solar absorption 57%
Standard colour



S155 GREY
Solar reflection 42%
Light reflection 48%
Solar absorption 59%

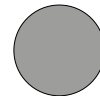

S120 AGATE GREY
Solar Reflection 41%
Light Reflection 41%
Solar Absorption 59%



B160 BLACK
Solar reflection 4%
Light reflection 4%
Solar absorption 96%



S156 METALLIC SILVER
Solar reflection 65%
Light reflection 62%
Solar absorption 35%



S158 SLATE GREY
Solar reflection 20%
Light reflection 21%
Solar absorption 80%



S159 ANTHRACITE
Solar reflection 12%
Light reflection 13%
Solar absorption 88%



S159 ANTHRACITE/S102 WHITE
Solar reflection 12%
Light reflection 13%
Solar absorption 88%



S125 BEIGE
Solar reflection 57%
Light reflection 63%
Solar absorption 43%



S142 LIGHT BLUE
Solar reflection 65%
Light reflection 69%
Solar absorption 35%



S130 GREEN
Solar reflection 58%
Light reflection 65%
Solar absorption 42%

*When the laminated glass option is chosen the only slat colours available are S102, S149 and S157.

slider, slideguide and headrail colour

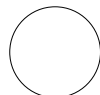

WHITE



BEIGE



LIGHT GREY



ANTHRACITE GREY



BLACK

*When the laminated glass option is chosen the only slider, slide guide and headrail colours available are White, Beige and Light Grey.

Glass

For refurbishment & renovation projects

Centre pane U=1.2 W/m²K

28mm clear low E

Laminated with clear low E (Doc Q)

For new build projects

Centre pane U=1.0 W/m²K

Laminated with solar control

(Doc Q)

How to operate

The **SL20SV** is operated by a cleverly-designed magnetic slider, positioned on the right or left-handed edge of glass. A narrow adhesive transparent profile ensures the linear movement of the slider. The blind is raised and lowered by moving the slider up or down and is tilted by slightly lifting or lowering the same slider.

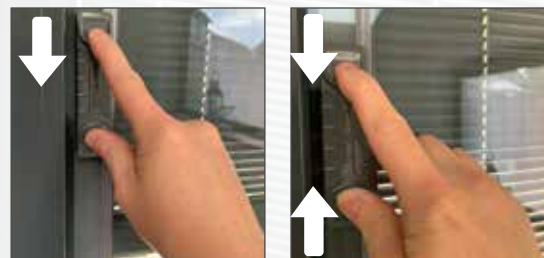
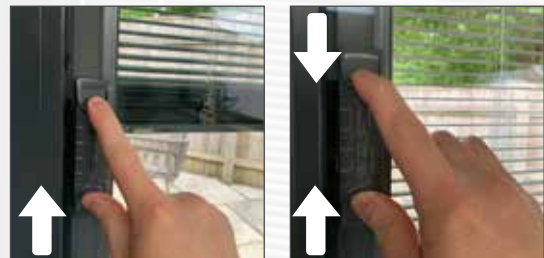

Specification and dimensions

Slim, beautiful sightlines

- Attractive, slim-line profiles with industry leading sightlines.
- Selection of stock colours on short lead times with bespoke options as you require
- Slimline, aluminium adjustable trickle air vents, colour matched to standard colour range.
- Trickle vent designs minimise additional frame and costs
- Bespoke Korniche locking and pull handles in a range of premium finishes

Fast & easy installation

- Oversize glass delivery service with crane unload*
- Patented SpeedBead clip-in glazing beads, the only aluminium clip-in bead which can be removed** quickly without damaging the paint finish. Wedge gasket not required, cutting down on installation time.
- The door is pre-assembled and ready to glaze, easy build kit-form option.
- Pre-assembled door panels are fabricated using strong, bonded and crimped mitred corners.
- Extensive protective packaging.
- Full Colour Installation booklet guide

* For glazed jobs with glass units that are over 1.2m wide we will provide a dedicated oversize glass handling service. A Crane equipped vehicle will be used and will require at least 3m of clear space around the vehicle to deploy outriggers and utilise crane. Glass will be delivered to kerbside only, customers MUST have the means to move the units to a safe area. The service carries a small surcharge.

** SpeedBead only for double-glazed units.

Strong and secure

- PAS 24 as standard with dual shoot bolt locking points and fibre reinforced guides.
- Anti-backdrive secondary shoot-bolt locking system stops external manipulation even when unlocked
- Low angle folding door shootbolt handle requiring only 120° of ergonomic rotation.
- Stainless-steel fixings, rails, hardened wheels and sealed rail bearings for class leading rolling smoothness and long life.
- Reinforcement as required by installation location

Thermally efficient

- Wide polyamide thermal breaks and fully thermally broken profiles and locking mechanisms.
- High performance EPDM and sealed brush-pile weather seals.
- Triple Glazed Options

Performance

- Document L compliant
- Document F compliant
- Air permeability: Class 3
- Water tightness: Class 7A
- Resistance to wind load: Class C5
- PAS 24:2022 enhanced security rated
- BS 6375 compliant
- DSER C Rated (Renovation / Replacement)*

* DSER or Door Set Energy Rating is a calculation of heat loss, solar gain, and the amount of air leakage which results in a rating letter. Compliance with building regs is achieved by a C rating for Renovation/Replacement projects.

Dimensions

- Frame depths : 120mm double track
185mm triple track
- Sash depth : 50mm
- Interlock Width : 47mm
- Glazing : 28mm double or 36mm triple glazed units
- Max frame width : 6400mm
- Max frame height* : 2578mm
- Max sash height : 2500mm
- Max sash width 2500mm
- Max glass unit weight: 250Kg

Glass

Options to suit all projects

Renovation / replacement options:

1. 28mm low E Toughened
2. 28.8mm low E Laminated
3. 36mm low E Toughened Triple
4. 36.8mm low E Laminated Triple

New build options:

1. 28.8mm Performance low E Laminated
2. 36.8mm Performance low E Laminated Triple

4mm Toughened glass supplied up to 1.2m width

6mm Toughened glass supplied over 1.2m width

Max Triple 1.3m width

All laminated options are P1A specification and Document Q compliant

**GLASS AND GLAZING
QUALITY CONTROL**

PASSED



LIGHTBOX INSPECTION

MFT

MADE FOR TRADE

IMPORTANT

Glass should only be rejected if a defect is visible when looking through the glass from 3 metres away in natural daylight.

Very small blemishes are expected in processed glass. This IGU has been checked and complies with GGF Quality of Vision Standards.

Scan QR code for full details.



Compliance



New build certification sticker applied to door casement



Refurbishment certification sticker applied to door casement

Cortizo 4700 sliding doors are factory certified, compliant with building regulations when purchased with glazing

Configuration options

- Available in any BS or RAL colours
- Double or triple track
- Doors up to 6400mm wide
- Height up to 2578mm
- Each sash up to 2500mm wide
- 2, 3, 4, 6 sashes



DC01



DC02



DC03

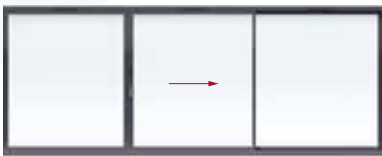

DC04



DC05



DC06

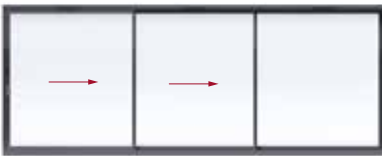

DC07



DC08

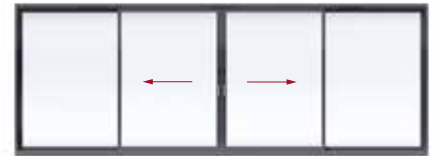

DC09



DC10

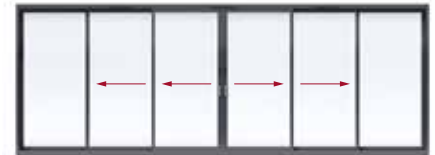

DC11

Survey guide

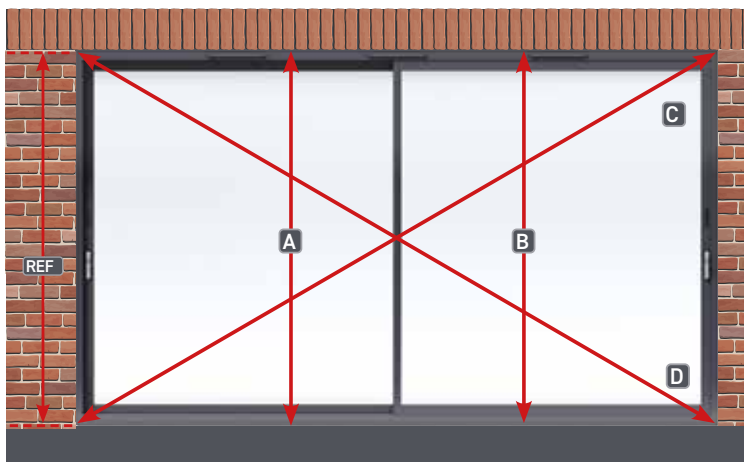

$$\text{REF} = \text{A} = \text{B} \pm 2\text{mm}$$

$$\text{C} = \text{D} \pm 2\text{mm}$$

Allow 10mm clearance to wall on height and width, opening must be square, observe above checking dimensions.

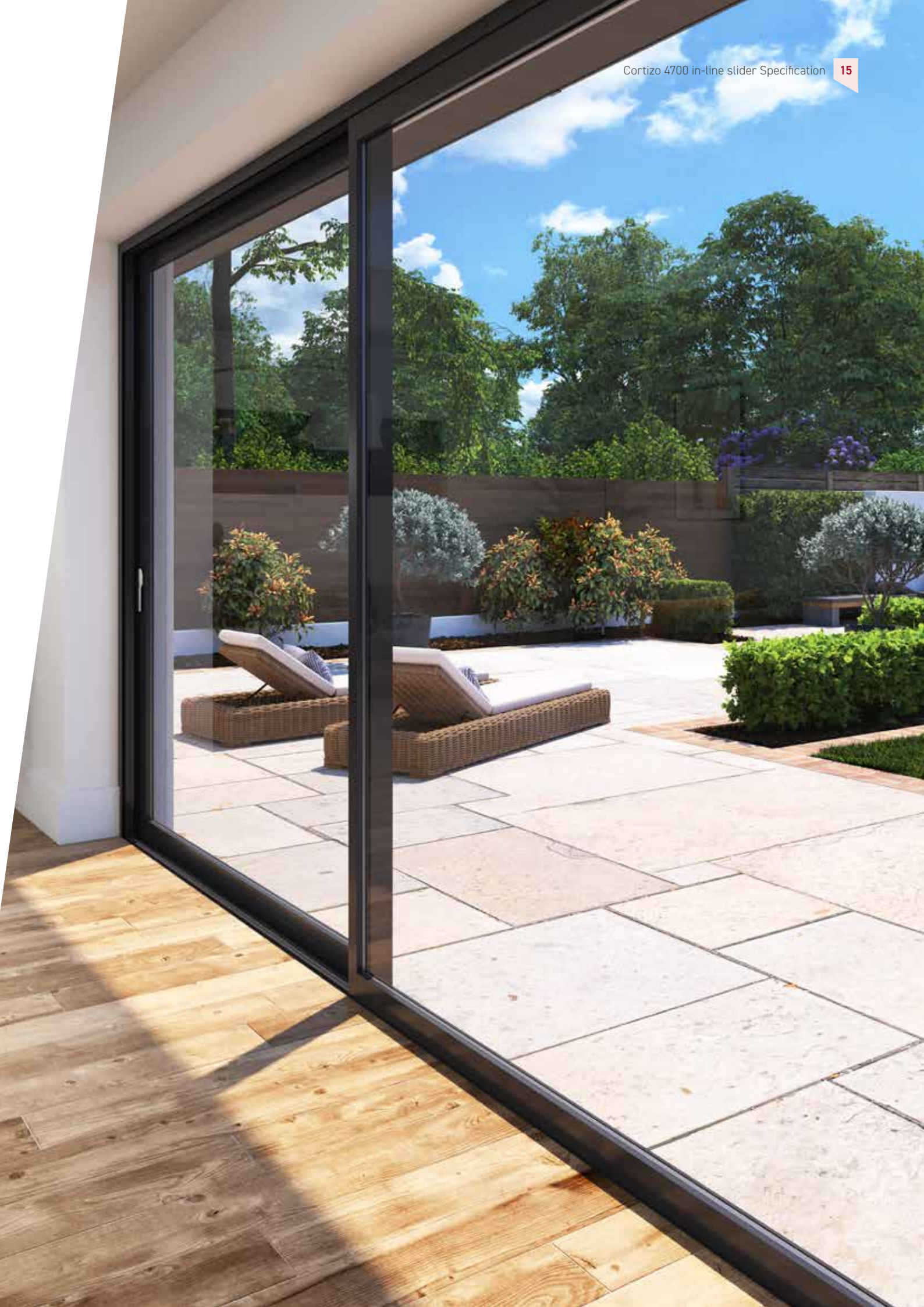

DOOR PROFILE INFORMATION

Dimensions

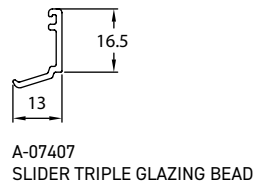
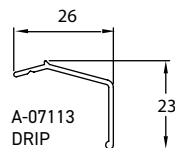
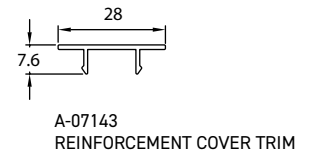
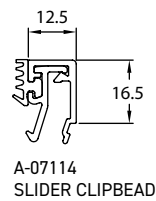
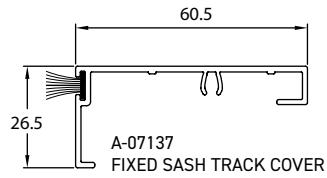
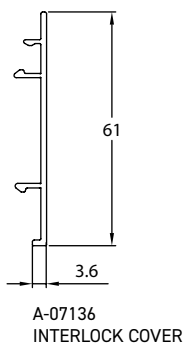
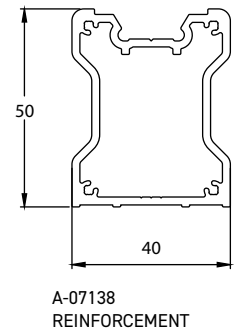
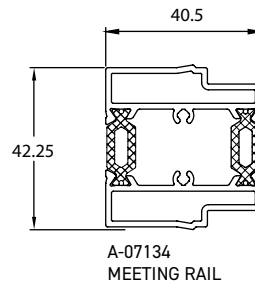
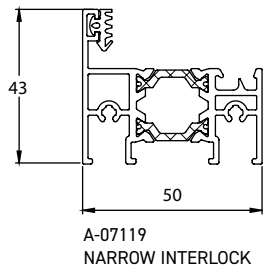
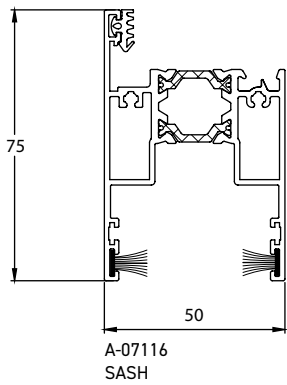
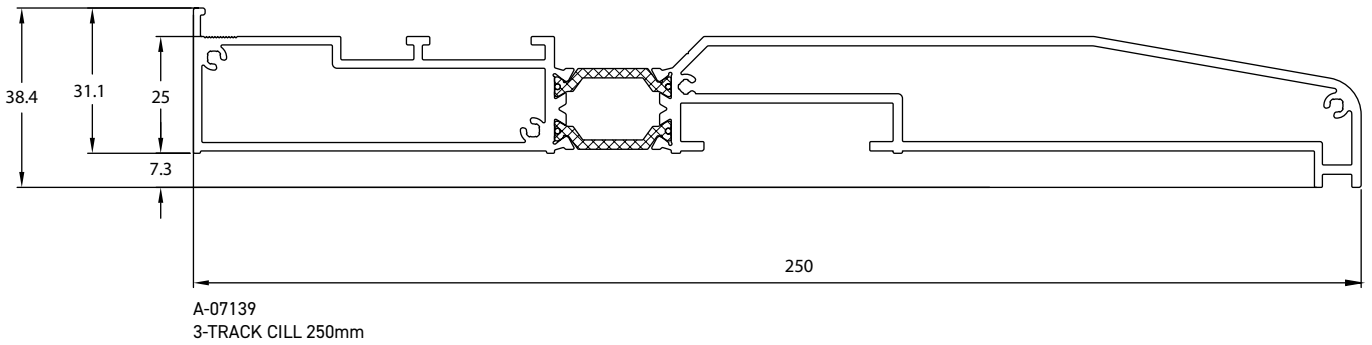
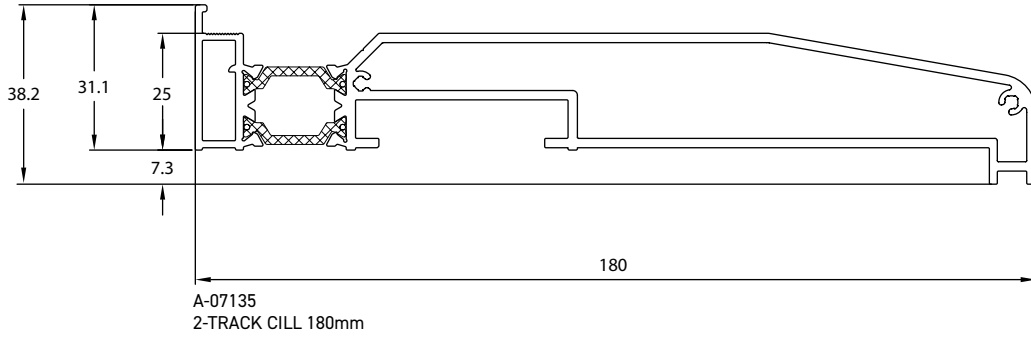

DOOR PROFILE INFORMATION

Dimensions

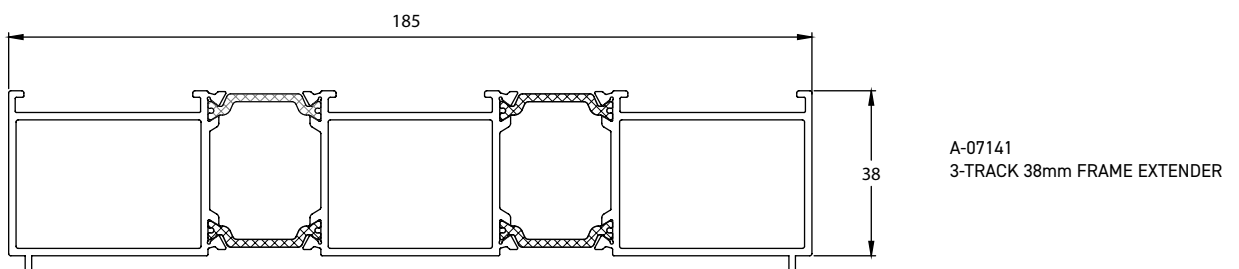
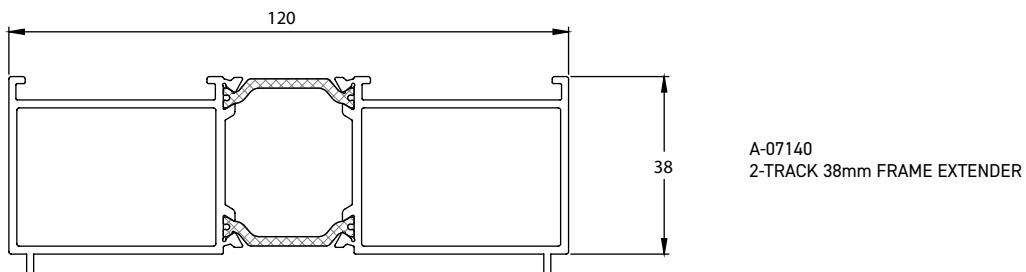
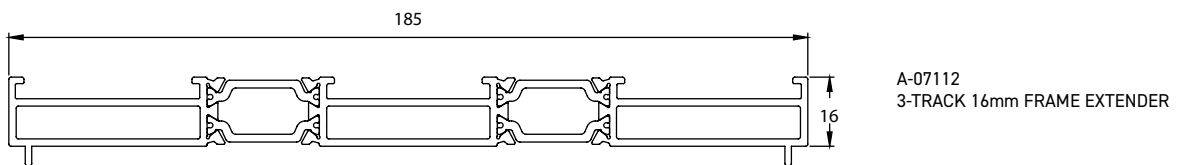
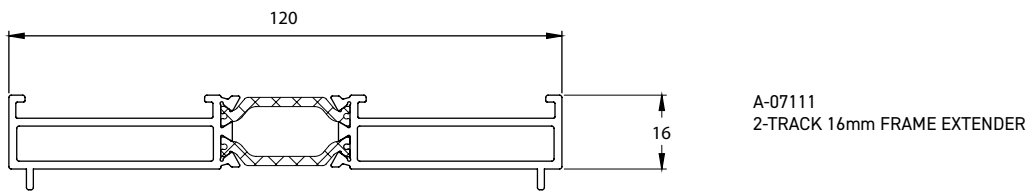
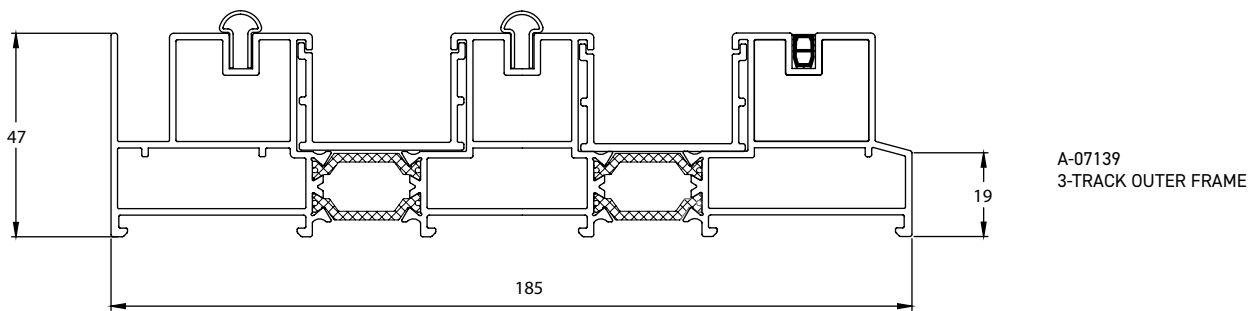
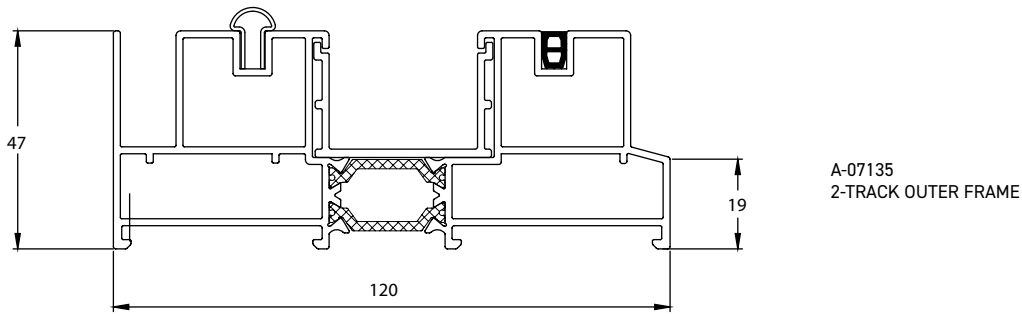

multi-award-winning aluminium manufacturing



The Korniche aluminium product range, has received multiple awards for its innovative design, engineering and aesthetics, including both builder and homeowner accreditation.

- ▀ The King's Award for Innovation 2024
- ▀ NFA Awards Finalist, 2024
- ▀ NFA Awards Winner, 2021, 2022, 2023
- ▀ Manufacturing ISO9001:2015 Quality accreditation 2022





Korniche products...

Specify with confidence, secure in the knowledge that the Korniche products you choose will be the perfect finish for your project.

For more information about the full multi-award-winning Korniche product range, and details of 'Where to Buy' please scan the QR Code below:

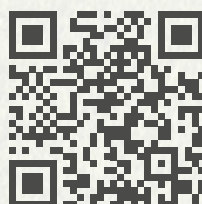

www.korniche.co.uk



transform
your space
with **Cortizo**
by **Korniche**



www.korniche.co.uk

